

EITEL-McCULLOUGH, INC.

SAN BRUNO, CALIFORNIA

152TL

LOW-MU TRIODE
 MODULATOR
 OSCILLATOR
 AMPLIFIER

GENERAL CHARACTERISTICS

ELECTRICAL

Filament: Thoriated tungsten	
Voltage - - - - -	5.0 of 10.0 volts
Current - - - - -	12.5 or 6.25 amperes
Amplification Factor (Average) - - - - -	12
Direct Interelectrode Capacitances (Average)	
Grid-Plate - - - - -	4.4 $\mu\mu\text{f}$
Grid-Filament - - - - -	4.5 $\mu\mu\text{f}$
Plate-Filament - - - - -	0.7 $\mu\mu\text{f}$
Transconductance ($i_b = 500 \text{ ma.}$, $E_b = 3000 \text{ v.}$, $E_c = -85 \text{ v.}$)	7150 umhos

MECHANICAL

Base - - - - -	Special 4 pin, No. 5000B
Basing - - - - -	RMA type 4BC
Maximum Overall Dimensions:	
Length - - - - -	7.625 inches
Diameter - - - - -	2.563 inches
Net weight - - - - -	7 ounces
Shipping weight (Average) - - - - -	2.0 pounds

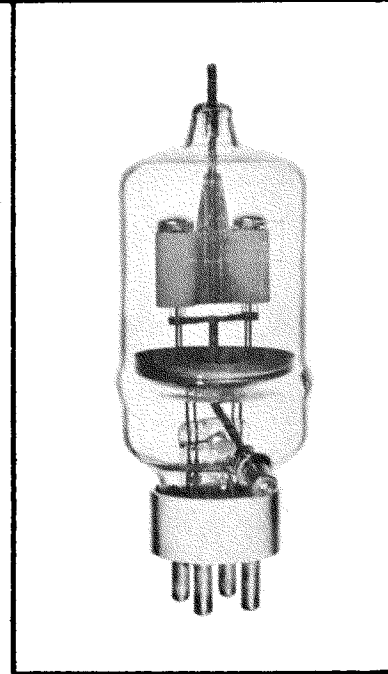

AUDIO FREQUENCY POWER AMPLIFIER AND MODULATOR

Class B

	ZERO GRID CURRENT OPERATION—2 TUBES			TYPICAL OPERATION 2 TUBES			MAX. RATING	
	1500	2000	3000	1500	2000	3000		
D-C Plate Voltage - - - - -	1500	2000	3000	1500	2000	3000	3000	volts
Max.-Sig. D-C Plate Current, per tube*	•	•	•	•	•	•	450	ma.
Plate Dissipation, per tube* - - -	•	•	•	•	•	•	150	watts
D-C Grid Voltage (approx.) - - - -	-105	-160	-260	-105	-160	-260		volts
Peak A-F Grid Input Voltage - - - -	210	320	520	500	620	675		volts
Zero-Signal D-C Plate Current - - -	135	100	65	135	100	65		ma.
Max.-Signal D-C Plate Current - - -	286	260	220	570	500	335		ma.
Max.-Signal Driving Power (approx.)	0	0	0	15	13	3		watts
Effective Load, Plate-to-Plate - - -	5100	10500	24000	5500	9000	20400		ohms
Max.-Signal Plate Power Output - - -	130	220	370	560	700	700		watts

*Averaged over any sinusoidal audio frequency cycle.

RADIO FREQUENCY POWER AMPLIFIER AND OSCILLATOR

Class-C *Telegraphy

(Key down conditions without modulation)

	TYPICAL OPERATION—1 TUBE			MAX. RATING	
	1500	2000	3000		
D-C Plate Voltage - - - - -	1500	2000	3000	3000	volts
D-C Plate Current - - - - -	333	300	250	450	ma.
D-C Grid Current - - - - -	45	42	40	75	ma.
D-C Grid Voltage - - - - -	-250	-300	-400		volts
Plate Power Output - - - - -	350	450	600		watts
Plate Input - - - - -	500	600	750		watts
Plate Dissipation - - - - -	150	150	150	150	watts
Peak R. F. Grid Input Voltage, (approx.) - - -	400	455	550		volts
Driving Power, (approx.) - - - - -	16	18	20		watts

*The above figures show actual measured tube performance, and do not allow for variations in circuit losses.

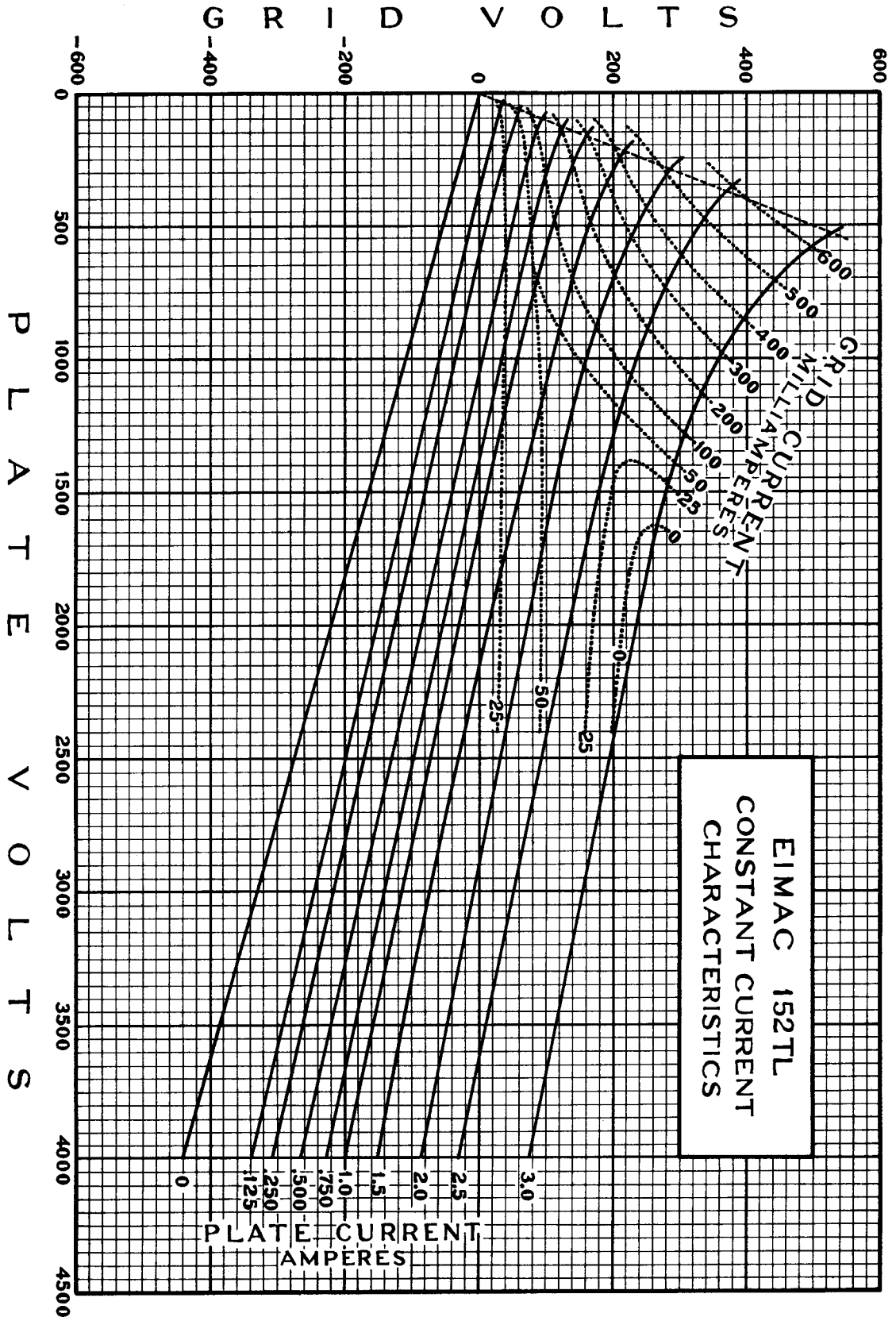

DRIVING POWER vs. POWER OUTPUT

The three charts on this page show the relationship of plate efficiency, power output and grid driving power at plate voltages of 1500, 2000 and 3000 volts. These charts show combined grid and bias losses only. The driving power and power output figures do not include circuit losses. The plate dissipation in watts is indicated by P_p .

Points A, B, and C are identical to the typical Class C operating conditions shown on the first page under 1500, 2000, and 3000 volts respectively.

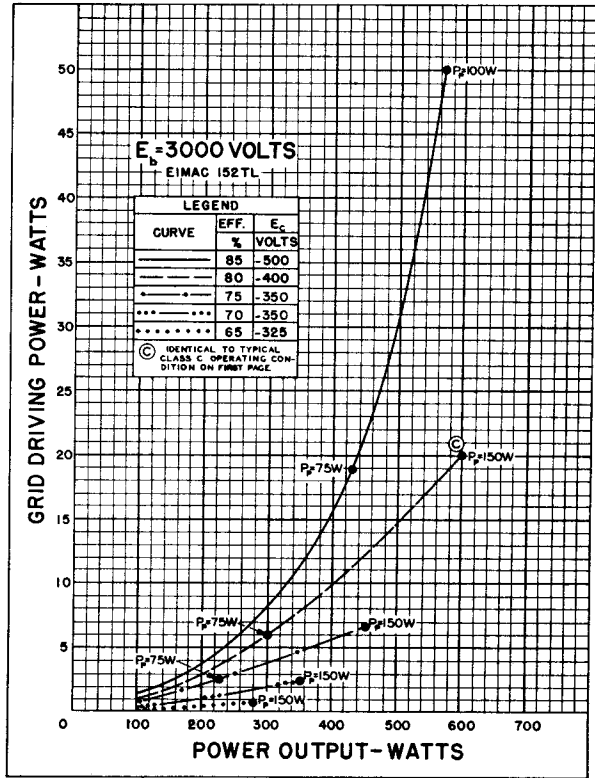
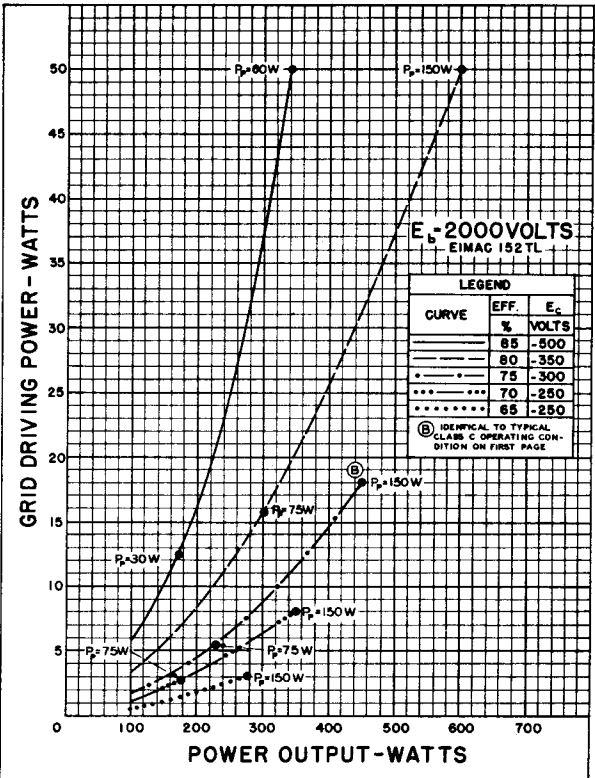
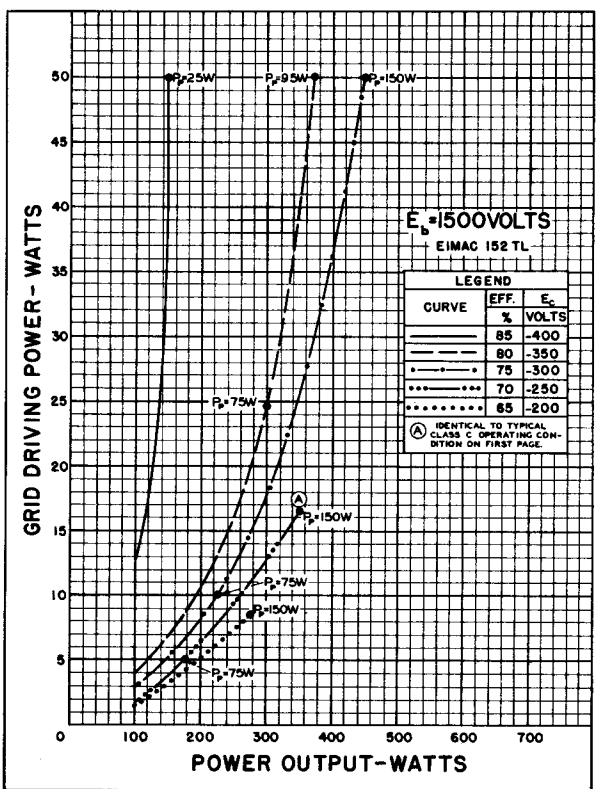

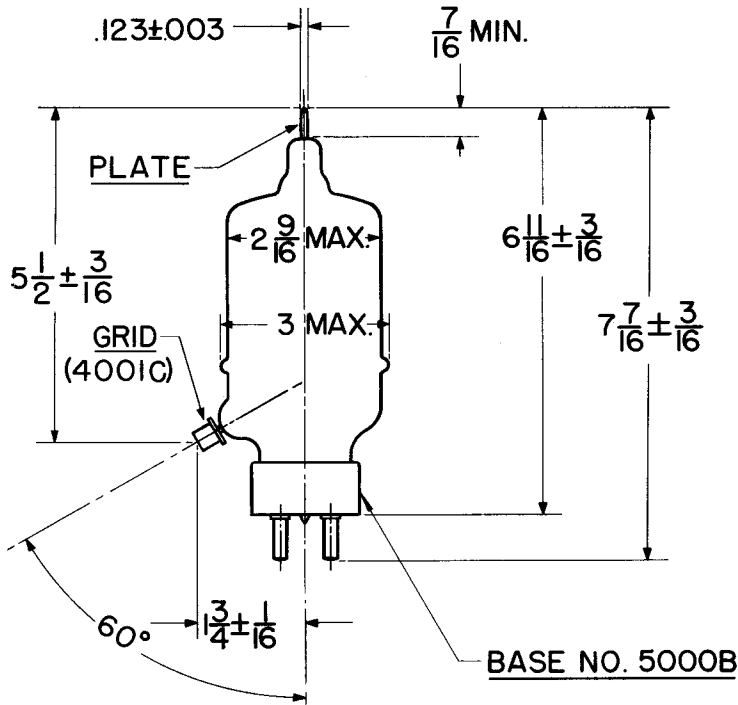
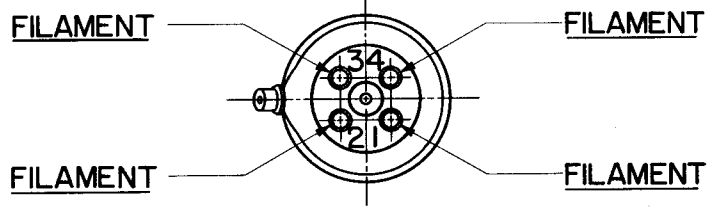
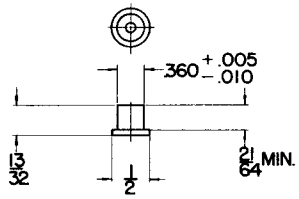
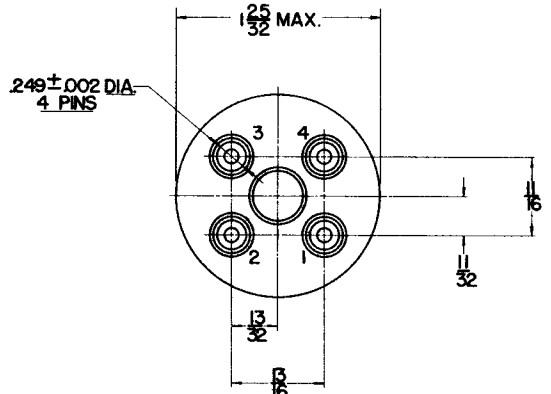
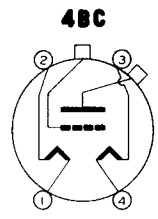
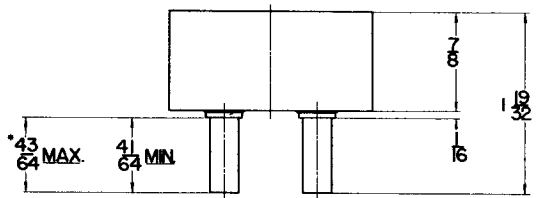

PLATE CAP
 (SEE TUBE OUTLINE DRAWING)

GRID CAP
 NO. 4001C



BASE NO. 5000B



*ON FINISHED TUBE ADD .060 FOR SOLDER